

Sito lato VOLT datasheet

LED wall/ceiling luminaire for exterior with spherical head and single-sided light output. For use on walls to illuminate steps or paths. Available either with spherical glass (Sito) or flat glass (Sito R) with internal lens, the lighting effect can be decided upon purchase.

The wall/ceiling luminaire complies with protection class IP65 and is thus dust-tight and jet-proof. Version for surface mounting, connection to 230 V (AC) mains voltage (VOLT light engine), dimmable via trailing-edge phase-cut dimmer*.

Other versions: Sito giro (ceiling luminaire), Sito verticale, Sito giù (wall luminaire), Sito basso (floor luminaire), Sito palo (bollard)

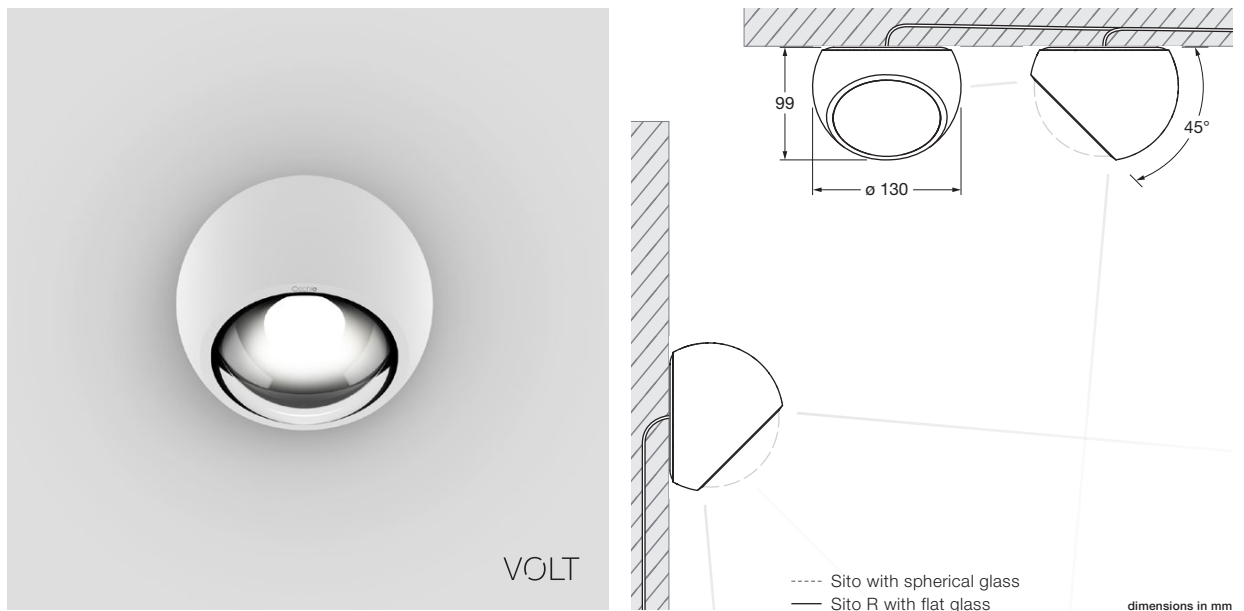

technical data Sito lato VOLT

properties	material	aluminium, painted, optical glass
	movability	45° (with stop and fixable)
	weight	1.5 kg
surface	head	matt white, glossy white, matt black
VOLT light engine	average life time	> 40.000 hrs
	energy efficiency class	A
	power	18 W
	color rendering index	perfect color; CRI Ra 97
	color temperature	2700 K, 3000 K
	recommended use	exterior and damp room
electricity	dimming	by trailing-edge phasecut dimmer*
	connection	230 V AC / 50 Hz
	permitted operating conditions	-20°C to +40°C

* For a list of compatible dimmers, see www.occhio.de/dim_en



Sito lato VOLT Sito lighting effects

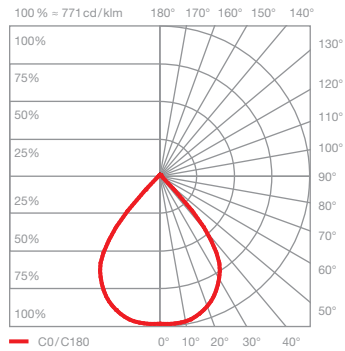

C80 contour

scattered light with contour beam angle
(approx. 80°)

inserts: spherical glass
 small lens medium

luminous flux: perfect color 18W 1100lm

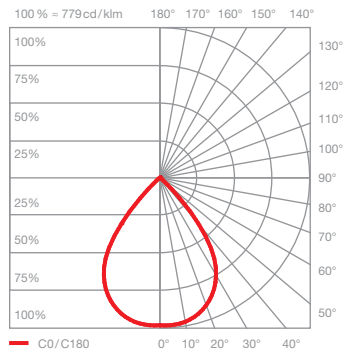
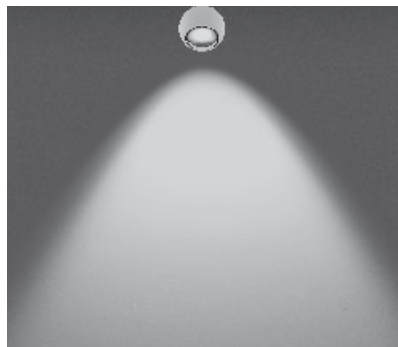

S80 soft

scattered light with soft contour beam angle
(approx. 80°)

inserts: spherical glass
 small lens medium
 soft edge glass

luminous flux: perfect color 18W 980lm

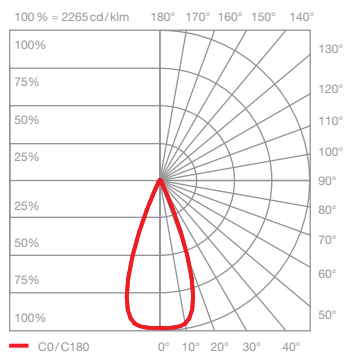

S40 soft

scattered light with soft contour beam angle
(approx. 40°)

inserts: spherical glass
 small lens high
 fresnel lens

luminous flux: perfect color 18W 870lm

Sito lato VOLT Sito R lighting effects

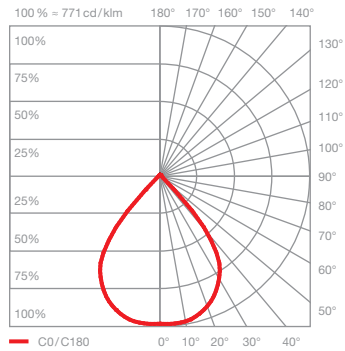

C80 contour

scattered light with contour beam angle
(approx. 80°)

inserts: flat glass
small lens medium

luminous flux: perfect color 18W 1100lm

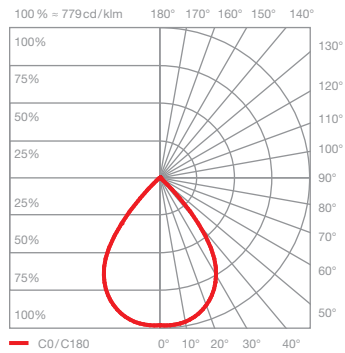

S80 soft

scattered light with soft contour beam angle
(approx. 80°)

inserts: flat glass
small lens medium
soft edge glass

luminous flux: perfect color 18W 980lm

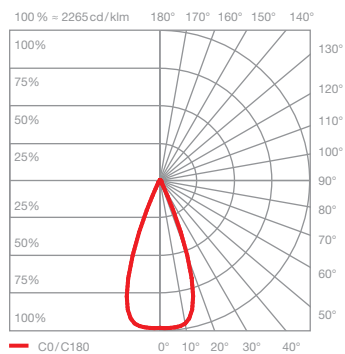
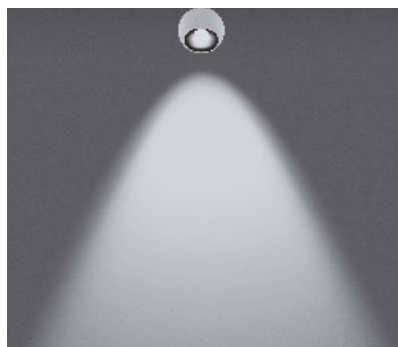

S40 soft

scattered light with soft contour beam angle
(approx. 40°)

inserts: flat glass
small lens high
fresnel lens

luminous flux: perfect color 18W 870lm

Sito lato VOLT connect several luminaires

through-wired with buried exterior
junction box

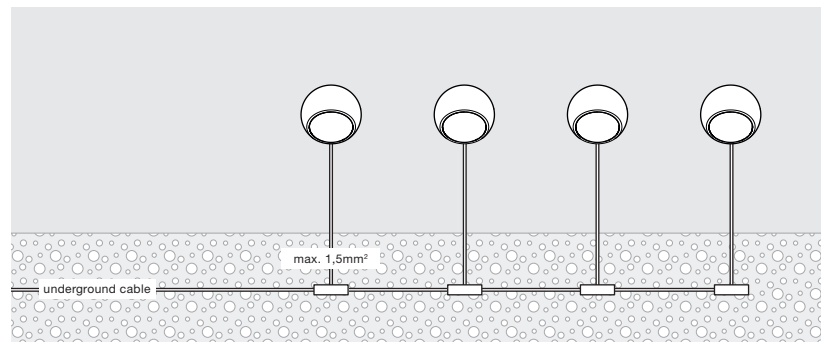

through-wired with plug in terminals

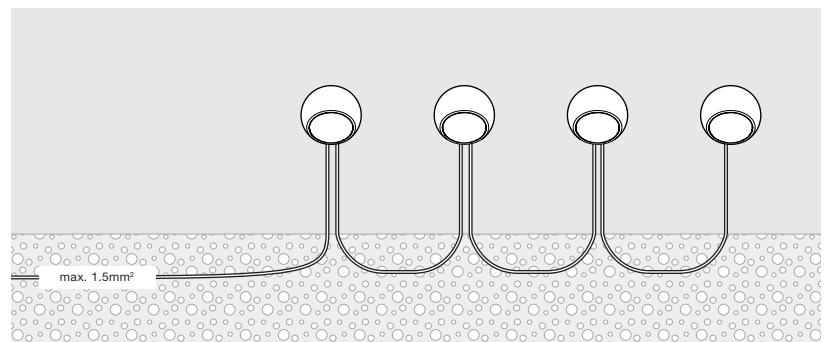

Occhio air module in switch box or
distribution box



max. 4 luminaires

